

## SPRINT 355 HIGH-SPEED INDUSTRIAL DOOR



**FULL-VISION HIGH-SPEED DOOR  
FOR FREQUENT TRAFFIC**

**ADVANCED SAFETY FEATURES INCLUDING  
NON-CONTACT **sara** SAFETY BEAM**

**SELF-RESETTING KNOCK-OUT FACILITY  
REDUCES RISK OF DAMAGE**

**ANODISED ALUMINIUM SIDE COLUMNS FOR  
GOOD LOOKS AND LOW MAINTENANCE**

**WIDE RANGE OF CONTROL OPTIONS**

**sara PRODUCTS DEFINE THE STANDARD**

# Sprint 355 high-speed industrial door



## Sprint 355 high-speed industrial door

High-speed roller doors with transparent door curtain providing excellent visibility for safety and daylighting.

Fast action minimises energy loss and draughts, and protects against vermin, insects and noise.

### Applications

Internal or external use for all types of industrial access, especially where frequent operation is required eg forklift truck operations.

Can also be used for conveyors or machinery supply systems.

### Features

Advanced safety system: non-contact **sara** safety beam provides a high standard of protection for personnel as well as vehicles.

Good wind resistance: Class 2 to EN 12424.

Wide range of control and activation systems.

Self-resetting knock-out facility impact protection to bottom rail.

Self-opening in case of power failure.

Automatically closes with timed delay.

### Authority

The door conforms with the applicable harmonised CE guidelines including EN 13241.

### Other door types

Other Sprint door models are available in other size ranges and options.

Other types of **sara** industrial doors are available to provide thermal insulation or fire protection.

### Materials and manufacture

Door curtain: transparent PVC with coloured reinforcing strips, which rolls onto an aluminium barrel. Anodised aluminium bottom rail. Curtain edges reinforced with wind tabs which are gripped in the side columns.

Side columns: self-supporting, extruded anodised aluminium, containing counterbalancing springs which are also used for tensioning against wind resistance.

Drive: robust geared electric motor.

Covers: aluminium barrel cover and plastic motor cover are standard for door height up to 2500mm, optional above this.

#### Options

Coated fabric curtain, with or without transparent area.

PVC curtain with silicon-free reinforcing strips in blue or black.

Rolltex fabric curtain, with or without vision panels.

In-line motor.

### Sizes

Clear opening size to order within the following limits:

Width 1000mm to 4000mm.

Height 1500mm to 4200mm.

Door width must be less than or equal to clear structural opening width.

### Appearance

Curtain reinforcing strips blue or red as standard.

Other colours available as options.

Bottom rail, side columns and barrel cover are natural anodised; colour coating is optional.

### Safety features

Non-contact **sara** safety beam

In the event of an obstruction a prunning photocell safety beam automatically reverses the closing door before it touches the obstruction. This provides greater personnel safety than any contact system.

Stationary photocell

In addition a stationary safety photocell beam in the side columns automatically sends the door to the fully open position if the doorway is obstructed.

Self-resetting knock-out facility

If there is an impact on the bottom rail, the rail and curtain break out of the side column guides and the door stops automatically. Closing the door will then automatically reset the rail in the guides without manual or mechanical adjustment.

Emergency opening

In the event of power failure, the door can be opened by releasing the brake manually. The door opens fully or partially, depending on the width/height ratio, and can easily be pushed fully open by hand if necessary.

### Operating speeds

See table below.

### Control and activation

Manual control panel with push-button controls and cycle counter is standard.

Diagnostic text display on ACS 80 system.

Automatic time delay closing is standard for all control systems.

#### Options

Up button on reverse side of doorway.

A range of automatic and remote activators including induction loops, photocells, radio/infra red transmitters, movement sensors, pull cords and card readers.

Klaxons, xenon beacons, and traffic lights with or without direction detection.

Dual opening heights: reduced for normal use, with full height opening for occasional large vehicles.

### Control and electrical data

Control system	ACS 80	ACS 60	ACS 50
Opening speed	2.5m/s	2.5m/s	1.0m/s
Closing speed	1.0m/s	1.0m/s	1.0m/s
Dual opening heights	optional	n/a	n/a
Power supply	3 phase 415V 50/60Hz	3 phase 415V 50/60Hz	3 phase 415V 50/60Hz
Fuse protection	10A	6.3A	6.3A
Control voltage	24V DC	24V DC	24V DC
Protection	IP 54	IP 55/65	IP 55
Motor power	0.75kW	0.75kW	0.75kW

# Sprint 355: General dimensions

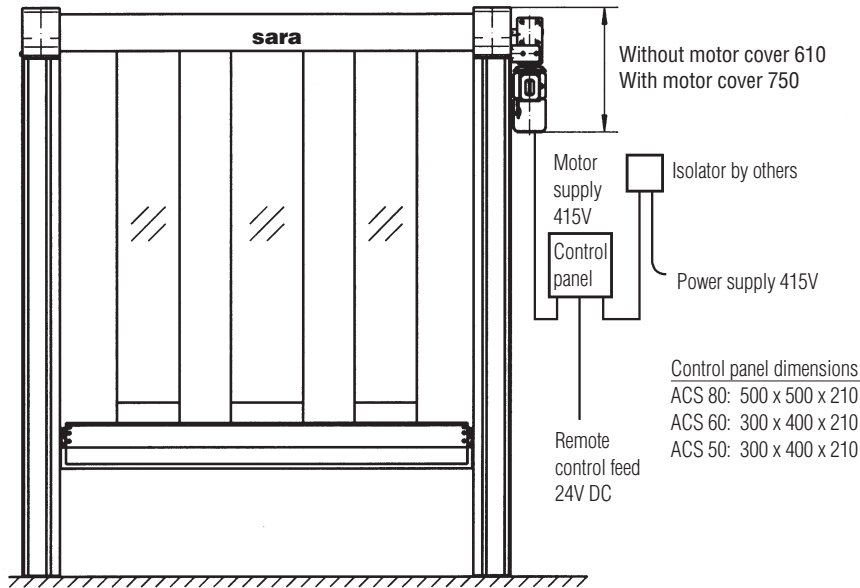

Elevation - direct drive

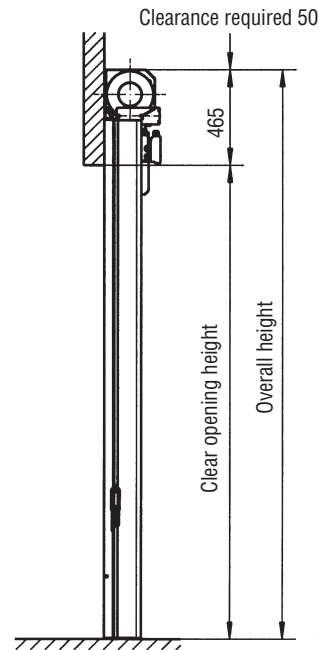

Vertical section - without barrel and motor cover

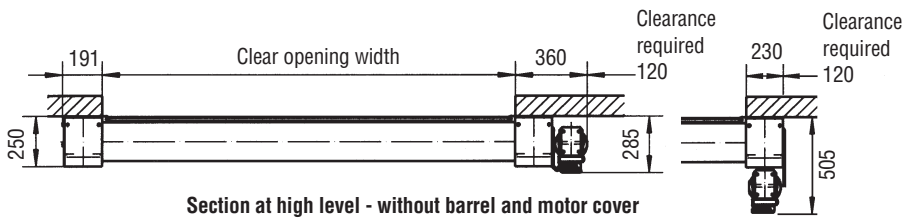

Section at high level - without barrel and motor cover

In-line motor option

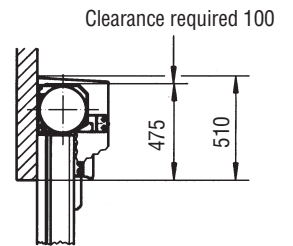

Vertical section - with barrel and motor cover

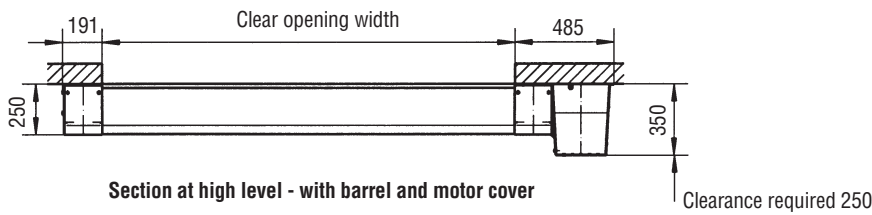

Section at high level - with barrel and motor cover

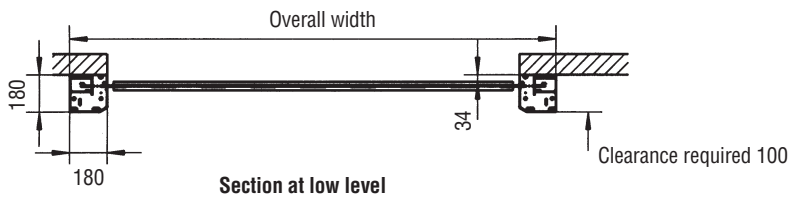

Section at low level

## Notes

Motor on right hand side is standard. On left to order.

For fixing positions see drawings overleaf.

To allow standard knock-out facility to operate, door width must be less than or equal to clear structural opening width.

5m control cable is standard.

All dimensions are mm

# Sprint 355: Fixing positions

**Fixing positions - over lintel**  
Use M12 or similar fixings

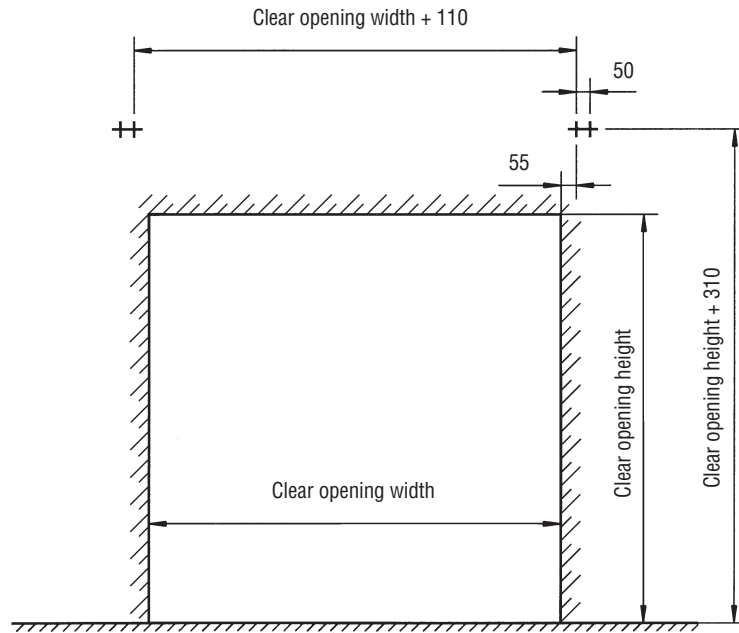

**Fixing positions - floor**  
Use M12 or similar fixings

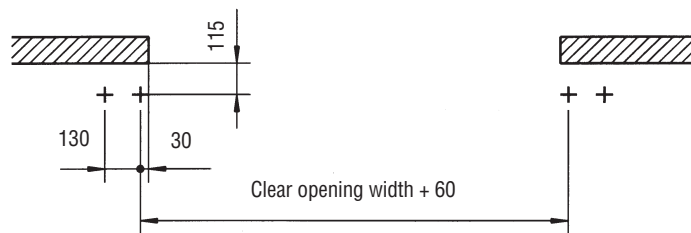

**Notes**

Fixing to steel frame (by others) requires minimum 200mm width fixing face.

All dimensions are mm

Please contact your **sara** Technical Salesman, who will be happy to discuss your requirements. The **sara** Sprint high-speed doors selector will help to identify the model appropriate to your project. Door demonstrations and site visits can also be arranged. Construction drawings and technical specifications (hard copy or disk) can be supplied on request.

## THE TOTAL PACKAGE

To complement the extensive range of high-speed doors we offer a total package of products including:

- INDUSTRIAL DOORS**
- SCISSOR LIFT TABLES**
- DOCK LEVELLERS**
- DOCK SEALS**
- LOADING RAMPS**

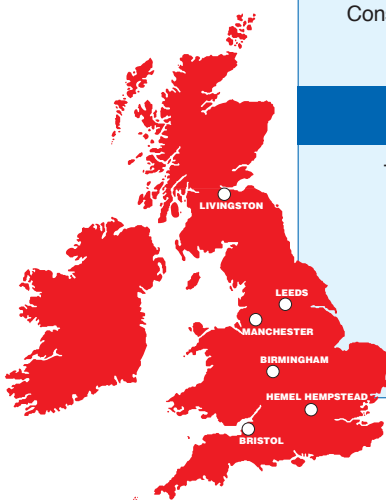

# sara®

Registered Trade Mark of Loading Bay Specialists Ltd.

**sara/Loading Bay Specialists Limited**

4 Garnett Close, Greycaine Estate, WATFORD, Herts. WD24 7JX. England

Telephone: 01923 208888 Fax: 01923 208899

Email: info@saralbs.co.uk Web: www.saralbs.co.uk



Association of Loading and Elevating Equipment Manufacturers.

